

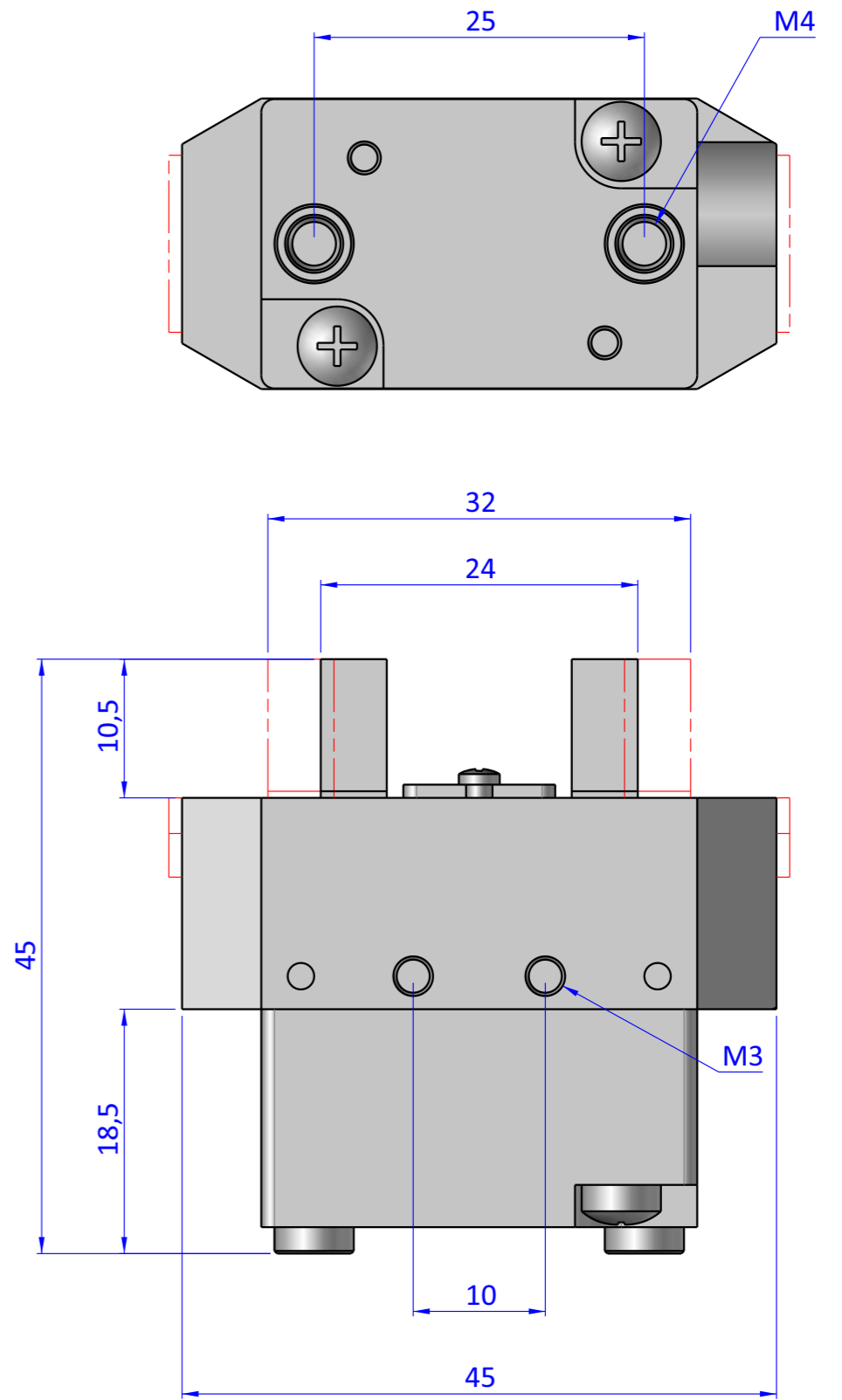

THE PROPERTY OF THE DRAWING IS ESTABLISHED BY LAW. IT IS FORBIDDEN TO PRODUCE OR SHOW IT TO THIRD PART. WITHOUT A WRITTEN AGREEMENT.

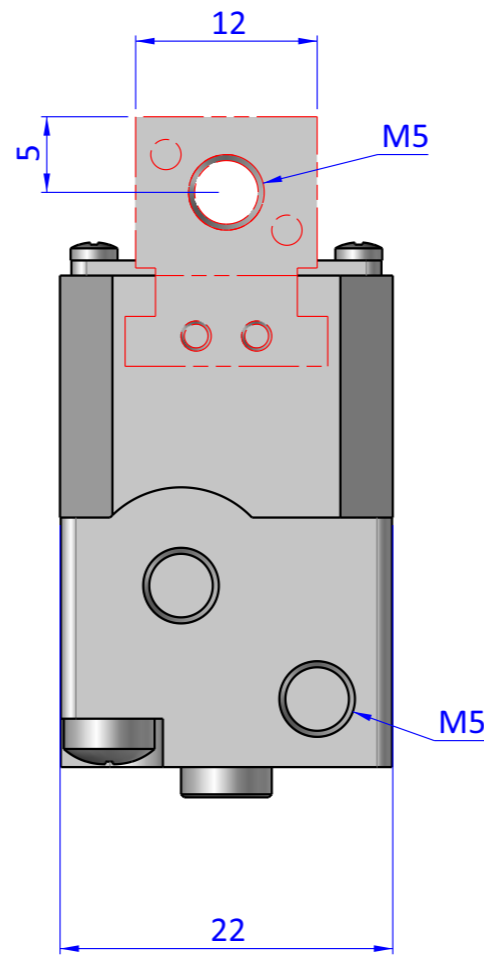
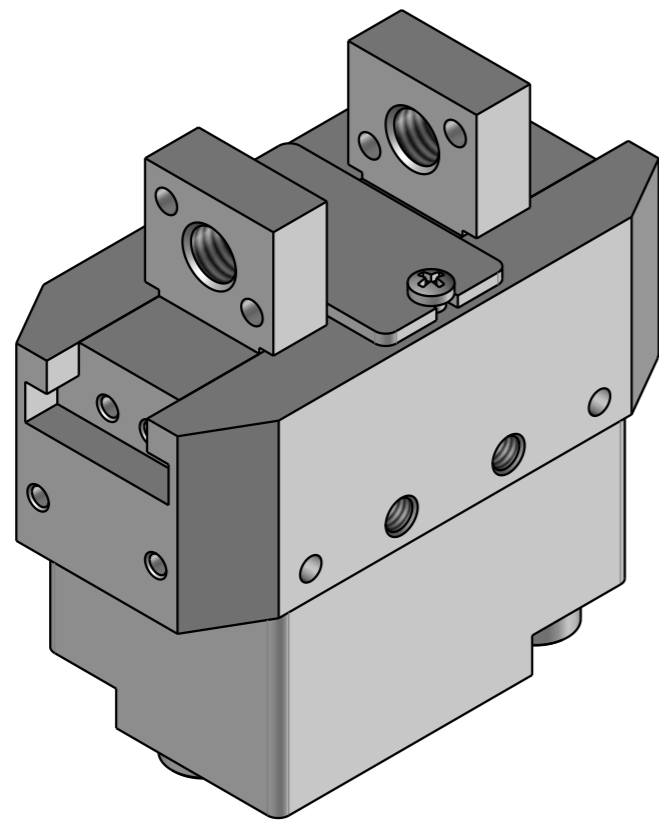

Format A3

UNI 936-76

 FPS FPSERVICES AUTOMATION		DESIGNED FROM		REVIEW
		FPS Automation		A
GENERAL TOLERANCE		DATE		WEIGHT
UNI - ISO 2768		01/04/2022		0,099kg
CLASSE f		CODE		
		CA.CGSP.32		CA.CGSP.32